

Radiator Fan and Condenser Fan <2AZ-FE>

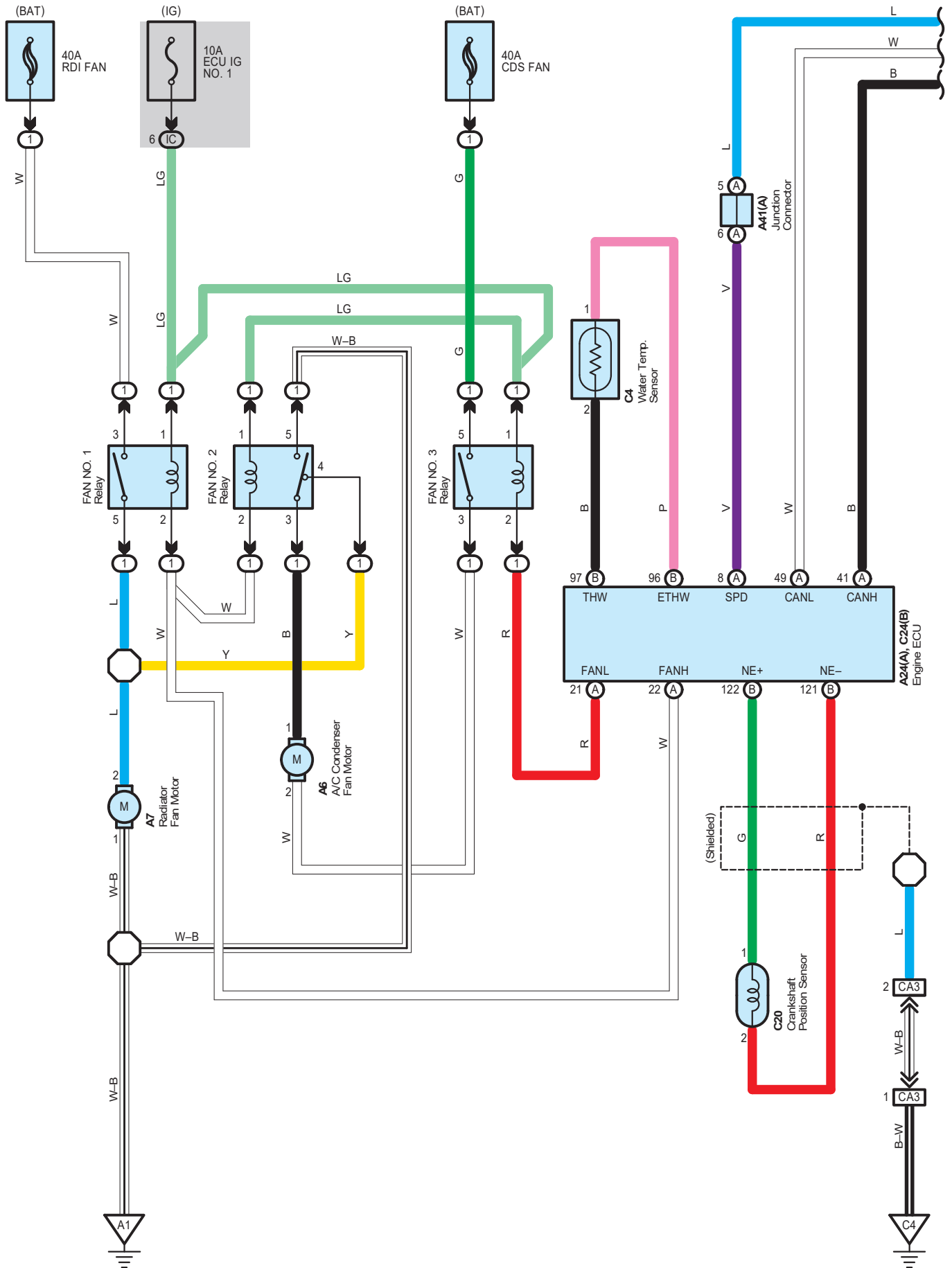

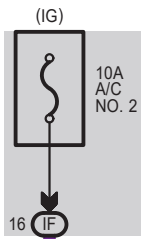

F16
A/C Control Assembly

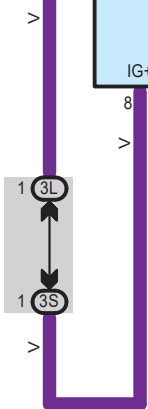
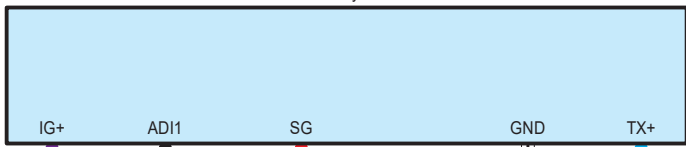

E18(A), a1(B)
Spiral Cable

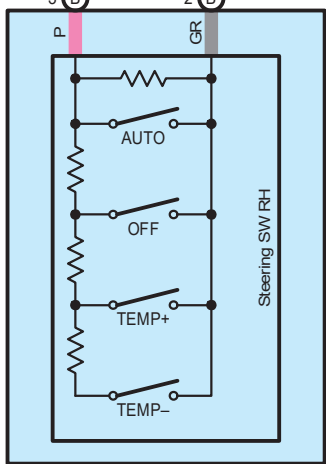

a1(B)
Steering Pad SW



A27
A/C Pressure Sensor



A56(A), E40(B)
Junction Connector

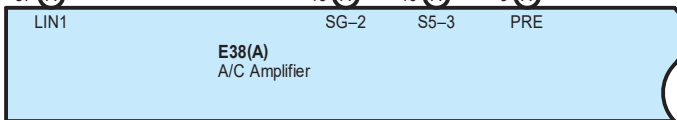
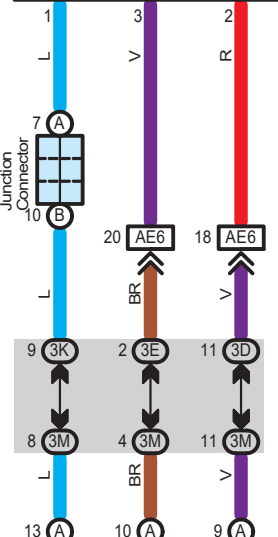

E38(A)
A/C Amplifier

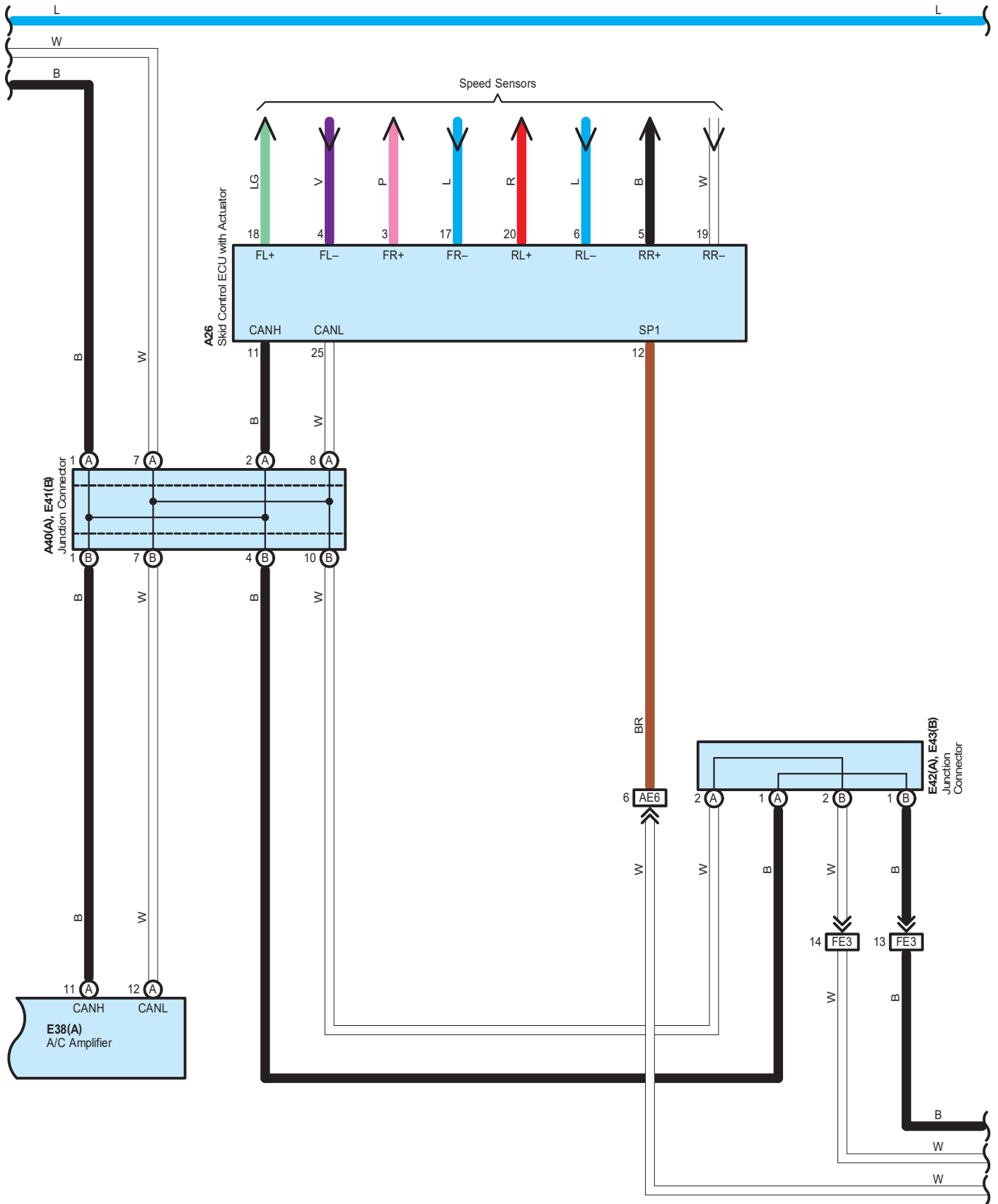

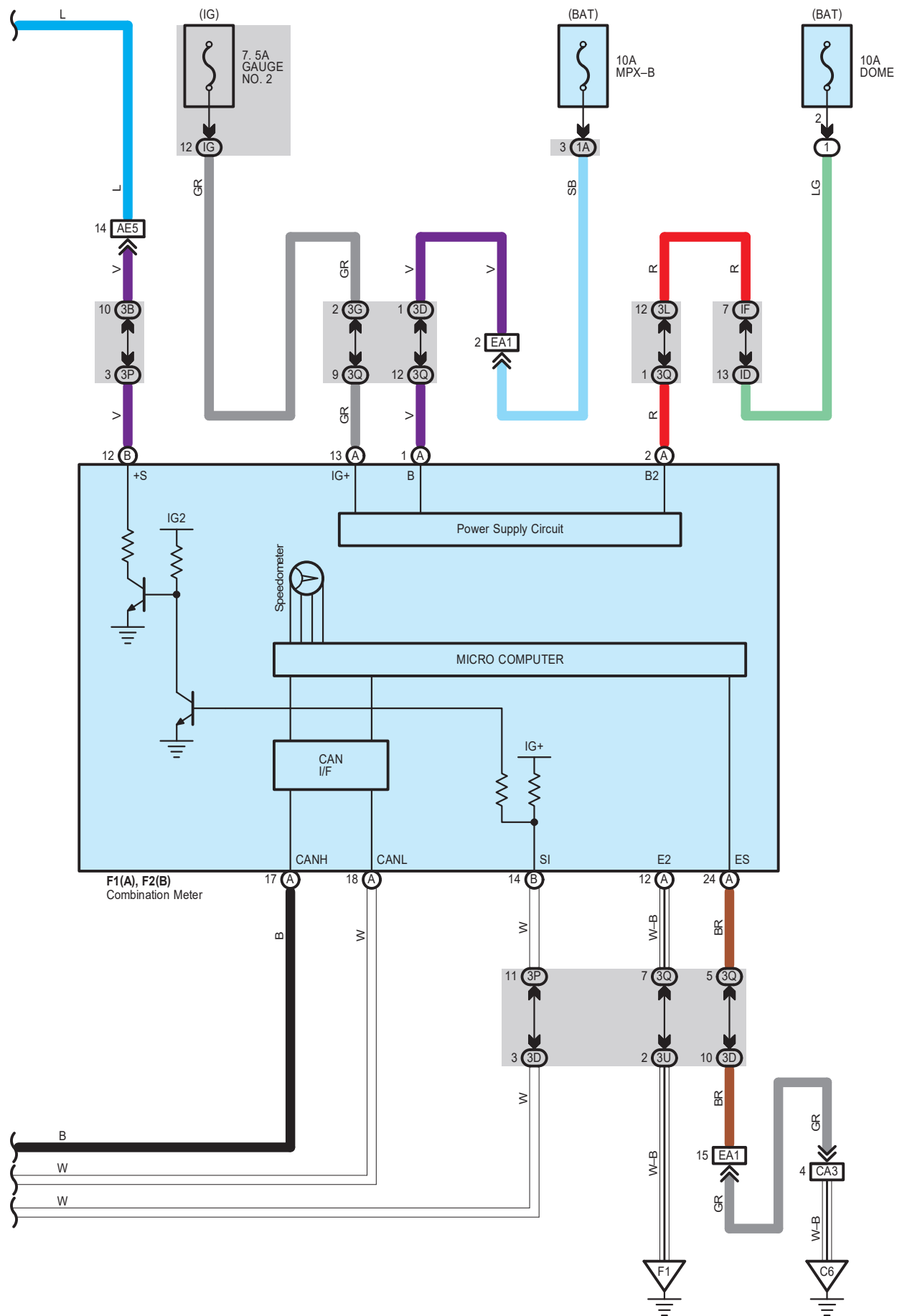

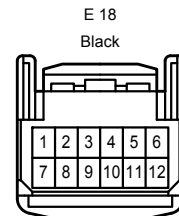
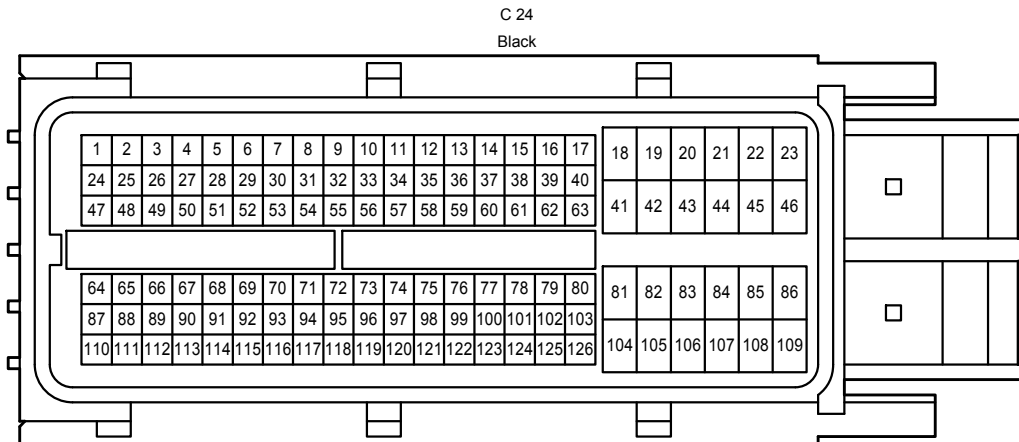
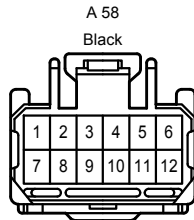
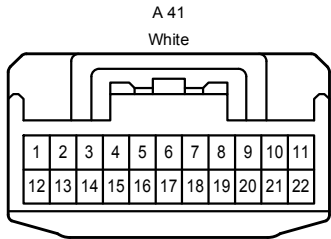
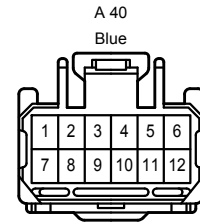
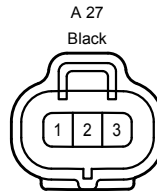
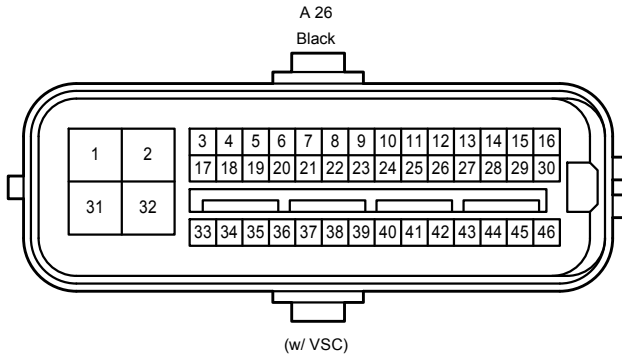
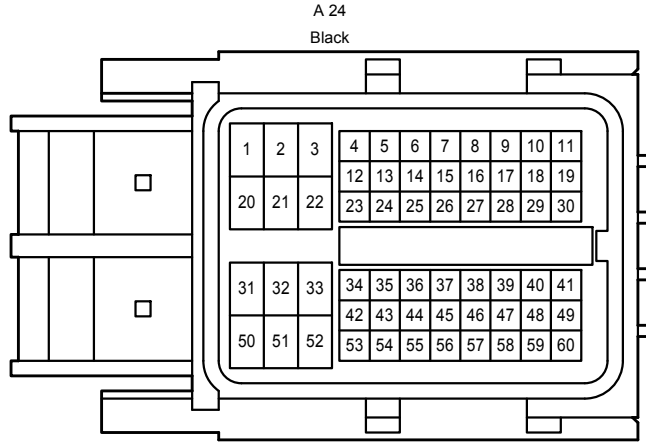
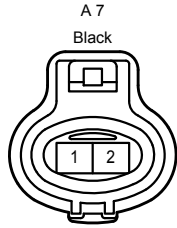
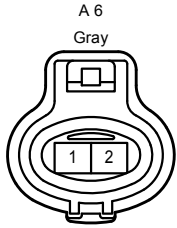

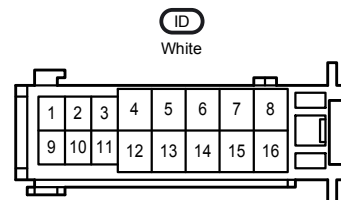
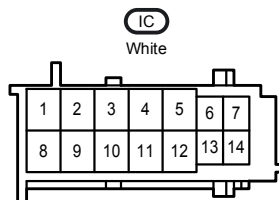
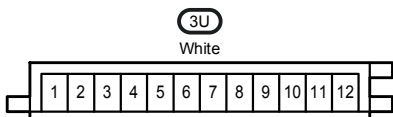
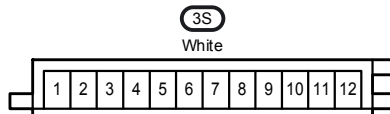
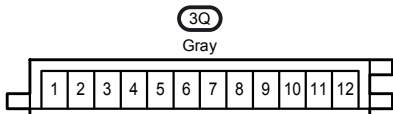
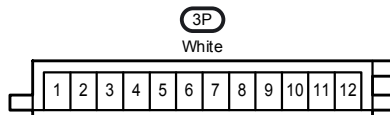
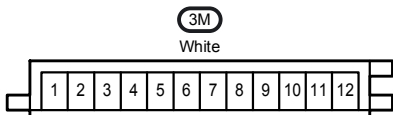
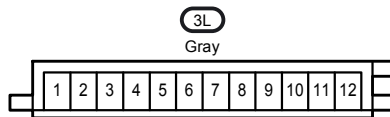
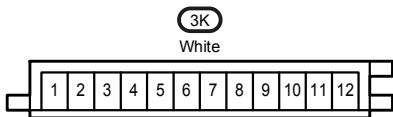
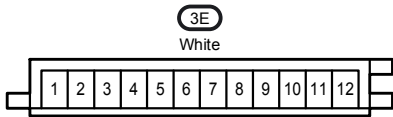
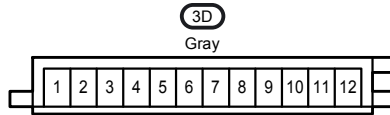
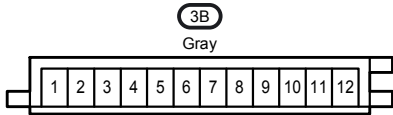
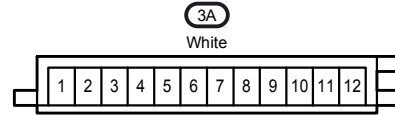
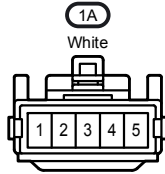
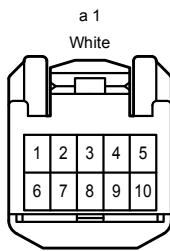
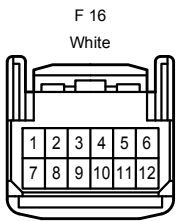
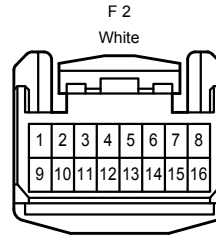
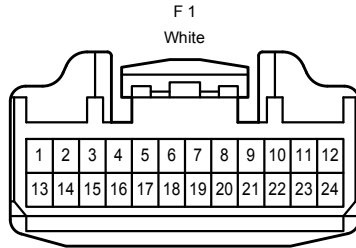
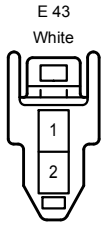
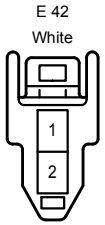
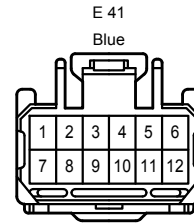
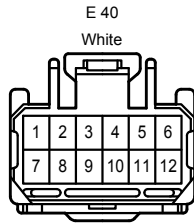
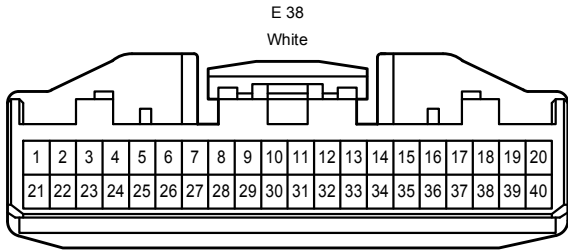

IF
White

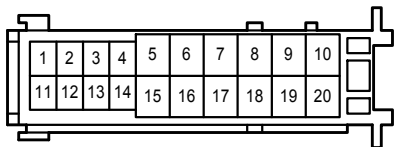

IG
White

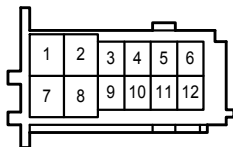

AE5
White

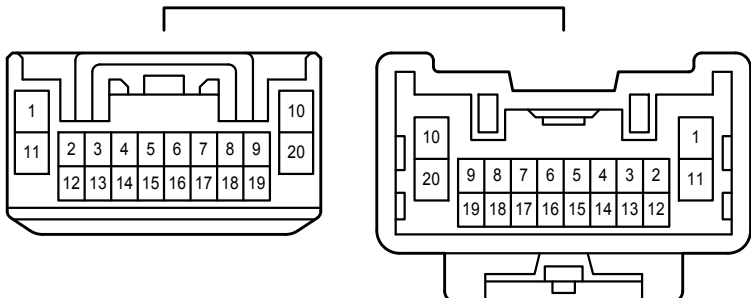

AE6
Gray

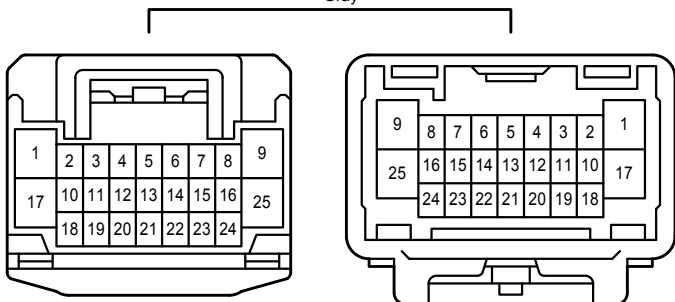

CA3
White

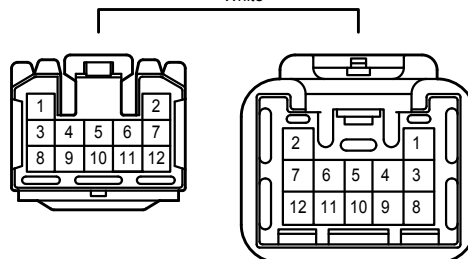

EA1
White

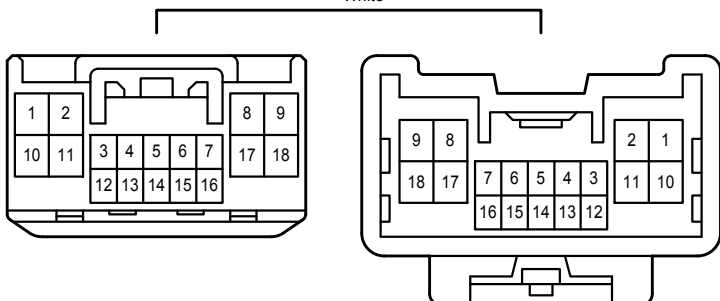

FE3
White

